

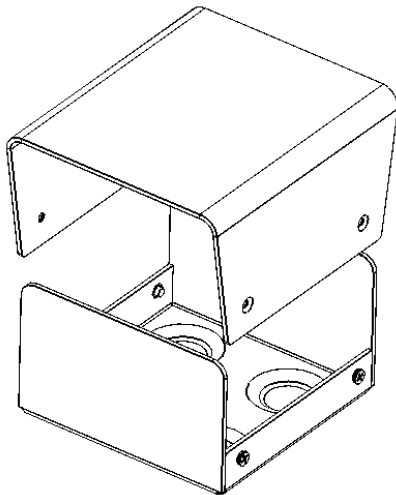

Worldwide OEM equipment supply

CSTM's Aluminum Project Box - DATASHEET

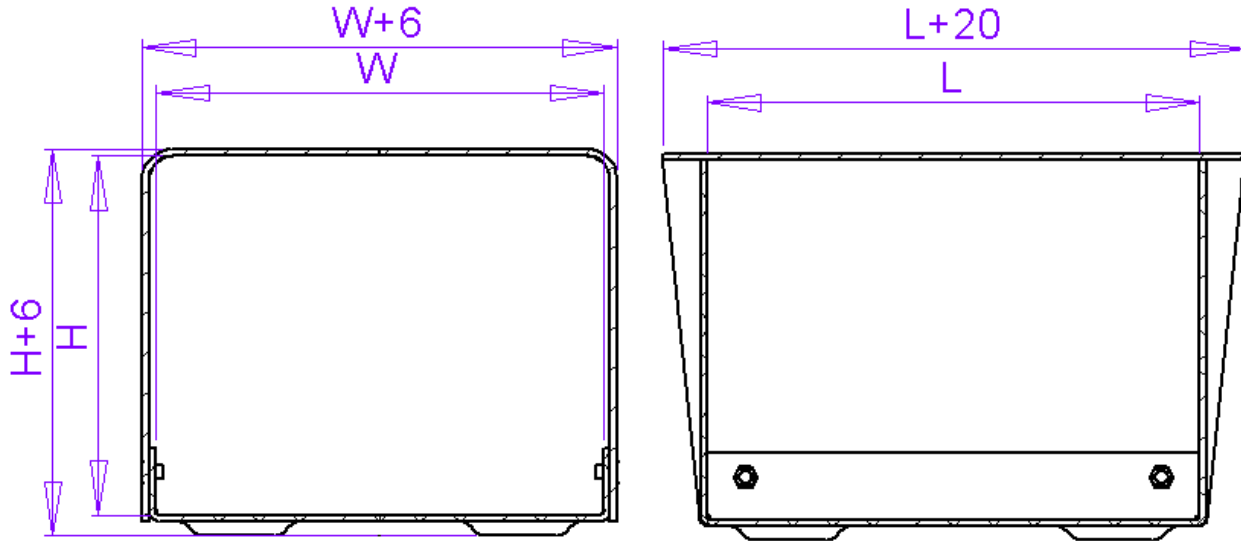

OEMix P/N: CSTM-HD2 - 90x90x60- P-7035

Elements	Base, Cover (bezeled)		
Int. Dimensions [mm] (Subtract 4mm for margins)	W	L	H
	90	90	60
Ext. Dimensions [mm]	We	Le	He
	96	110	66
Finish	a. Conv. coat MIL-C-5541 Class 3 b. Gray paint RAL#7035		
External Clamping	None		
Al Sheet thickness [mm]	1.5		

For more information please see www.OEMix.com