

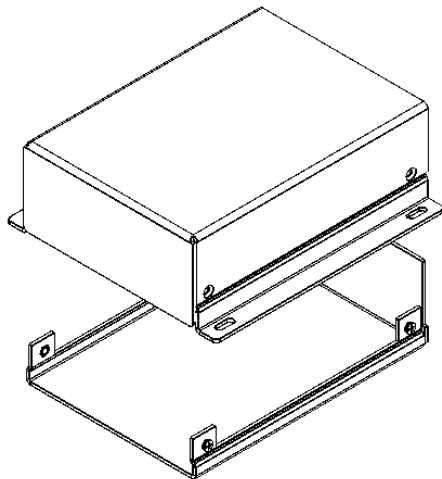

Worldwide OEM equipment supply

CSTM's Aluminum Project Box - DATASHEET

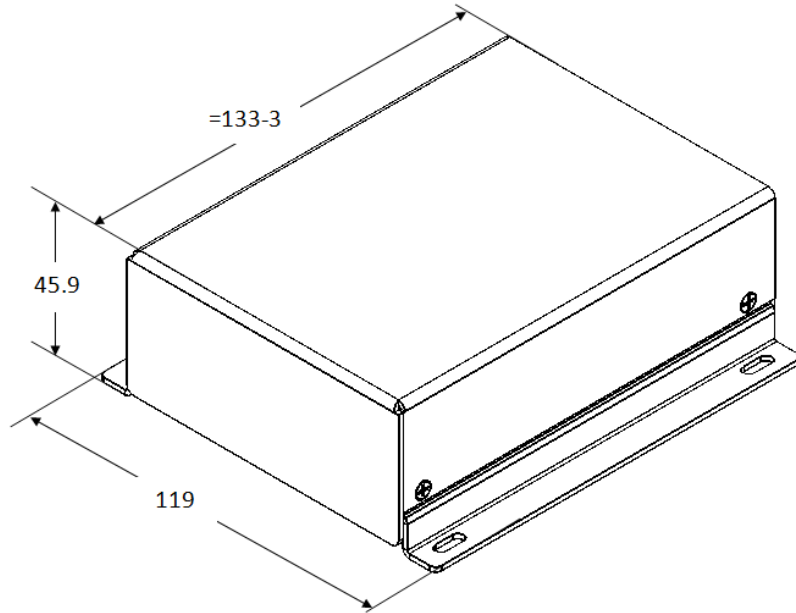

OEMix P/N: CSTM-FR1 - 90X130X40 - P-7035

| | | | |
|--|--|-----|------|
| Elements | Base, Cover and two panels | | |
| Int. Dimensions [mm] (Subtract 4mm for margins) | W | L | H |
| | 90 | 130 | 40 |
| Ext. Dimensions [mm] | W | L | H |
| | 119 | 133 | 45.9 |
| Finish | a. Conv. coat MIL-C-5541 Class 3 b. Gray paint RAL#7035 | | |
| Clamping | 4 elongated slots | | |
| Al Sheet thickness [mm] | 1.5 | | |

For more information please see www.OEMix.com