

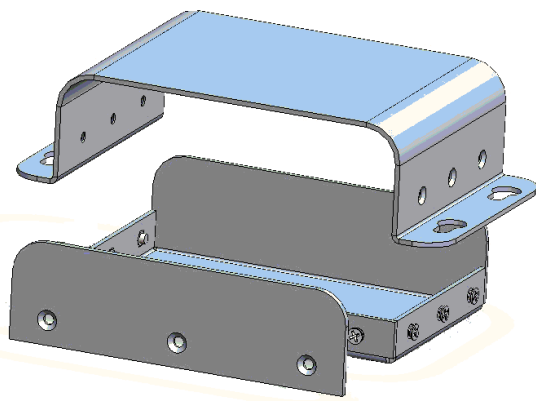

Worldwide OEM equipment supply

CSTM's Aluminum Project Box - DATASHEET

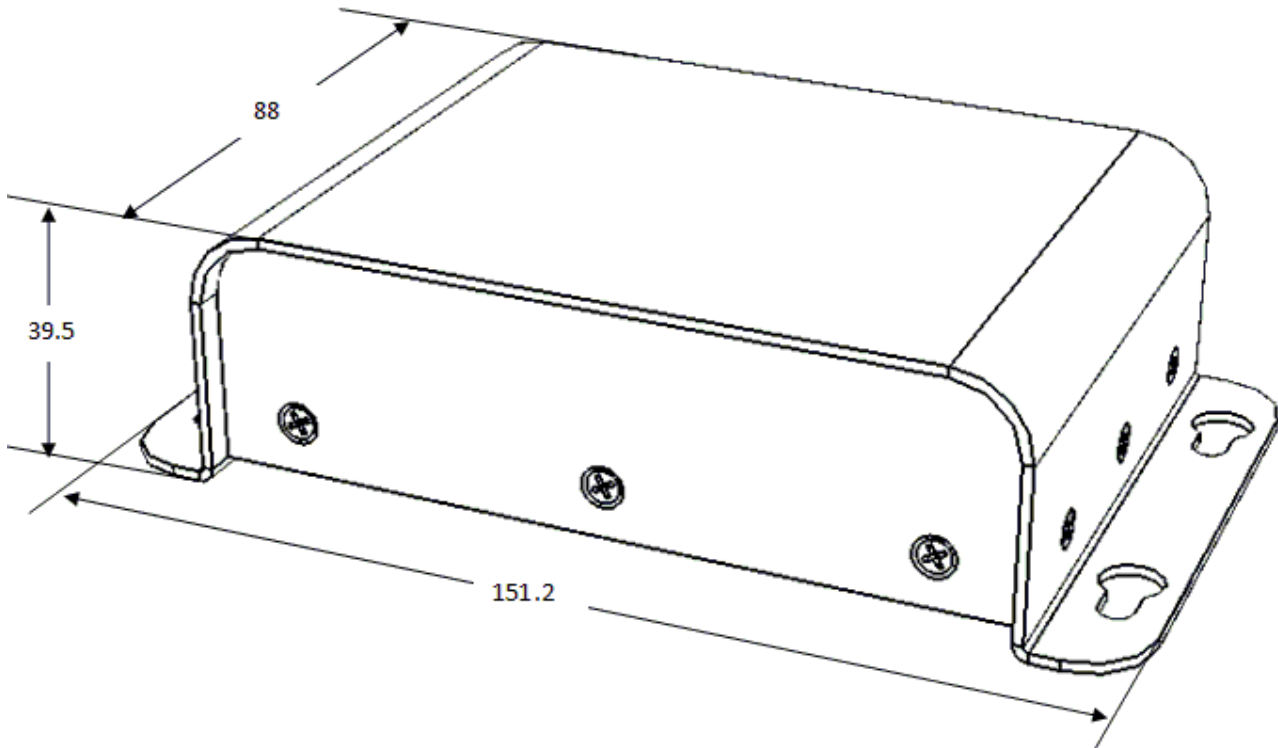

OEMix P/N: CSTM-FT3 - 115x75x34 - P-7035

Elements	Base, Cover, Panel
Int. Dimensions [mm] (Subtract 4mm for margins)	W 115 X L 75 X H34
Ext. Dimensions [mm]	W 151.2 X L 88X H 39.5
Finish	a. Conv. coat MIL-C-5541 Class 3 b. Gray PU paint RAL#7035
Clamping	4 Keyhole slots (panel up)
Al Sheet thickness [mm]	1.5

For more information please see www.OEMix.com