

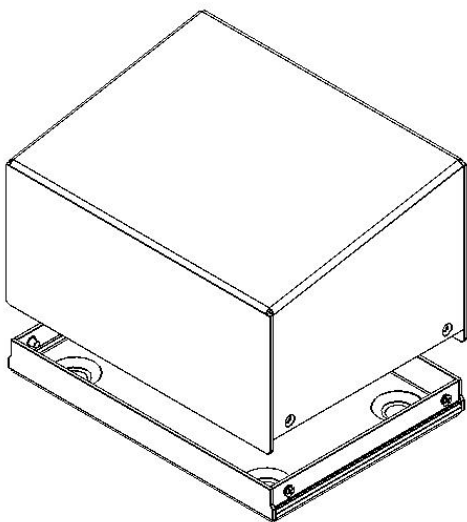

Worldwide OEM equipment supply

CSTM's Aluminum Project Box - DATASHEET

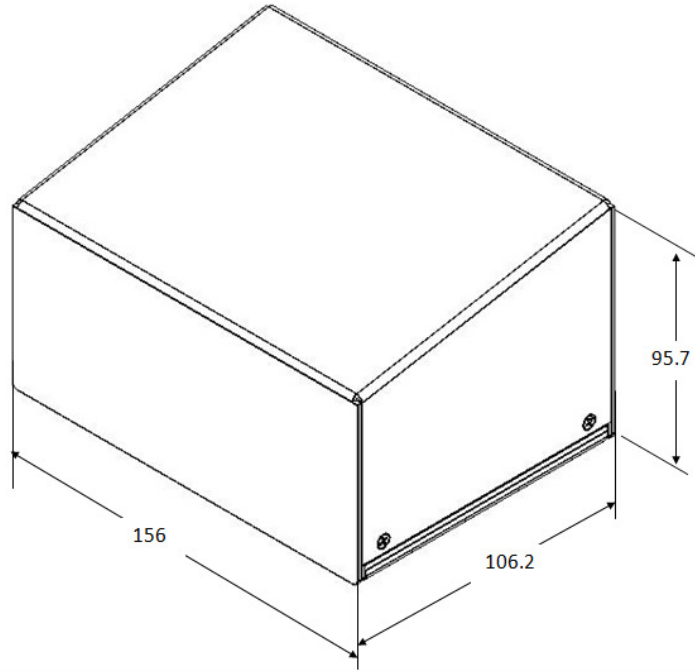

OEMix P/N: CSTM-INC1 - 150X100X70 - P-7035

Elements	Base, Cover		
Int. Dimensions [mm] (Subtract 4mm for margins)	W	L	H_{MIN}
	150	100	69.3
Ext. Dimensions [mm]	W	L	H_{MAX}
	156	106.2	95.7
Finish	a. Conv. coat MIL-C-5541 Class 3 b. Gray paint RAL#7035		
External Clamping	No t for clamping		
Al Sheet thickness [mm]	1.5		

For more information please see www.OEMix.com