

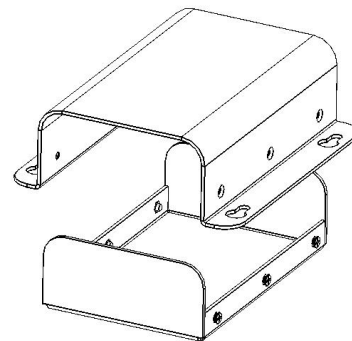

CSTM
R&D Solutions



Data Sheet and selection table for FT2 Series

FT2 Features:

Design: rounded cover

Parts: Base, cover

Material: Al sheet 1.5mm

Finishing: Anodize, Passivation, Paint

Support: Continuous side anchors

Base: slightly elevated from clamping surface

Clamping: 4 "keyholes" for rapid displacement

Selection: PCB "Length" - under 145mm, PCB area - under 142 cm²

Protruding components: possible on one side of the PCB only

Use the following P/N field definition for ordering:

CSTM - **FT2** - **WxLxH** - **A\P\C** - **Alphanumeric**

CSTM - fixed Prefix

FT2 - series indicator Prefix

WxLxH - is the "Mid P/N" defined by the inner dimensions WxLxH

A\P\C - finishing options: Anodize\Paint\Coating

Alphanumeric - takes paint RAL color No. or Anodize color

Finishing options defined by the A\P\C field:

A - Anodize: According to MIL-A-8625. Select Anodize color (Black, Natural, Gold, Brown)

P - PU paint upon a passivation layer. Selection of any RAL No. (default 7035)

C - Conversion Coating passivation according to MIL-C-5541E Class 3 (Yellowish)



CSTM
R&D Solutions

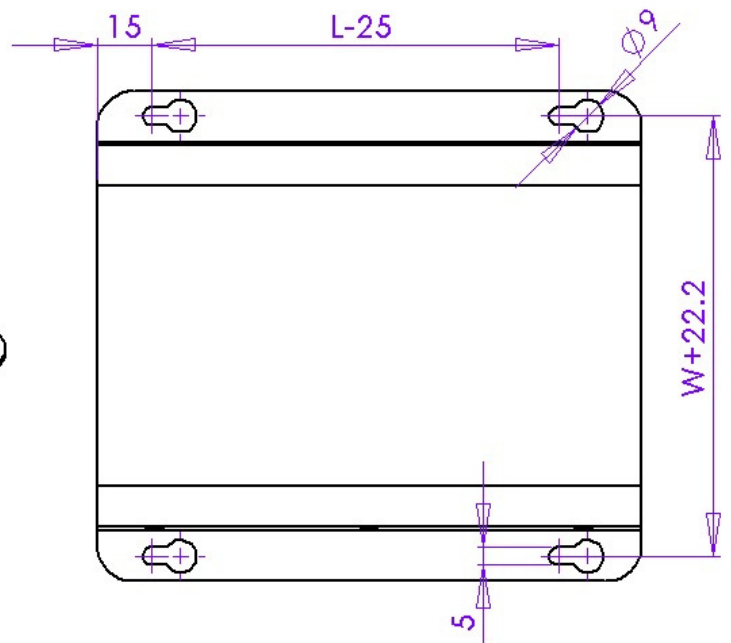
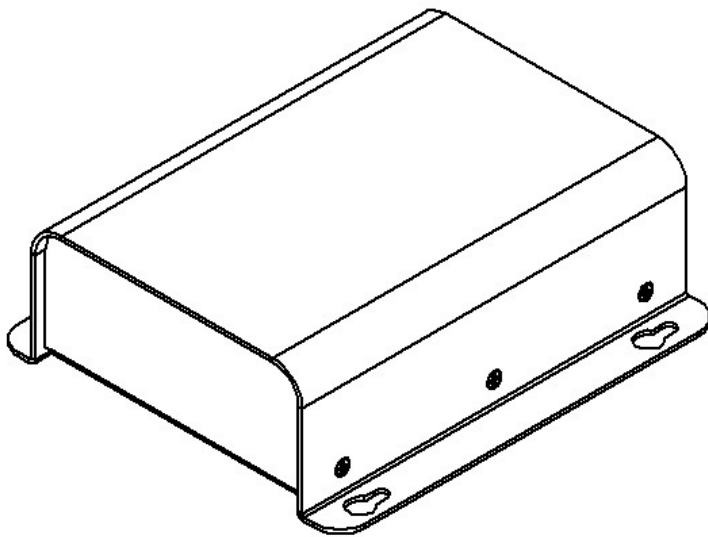
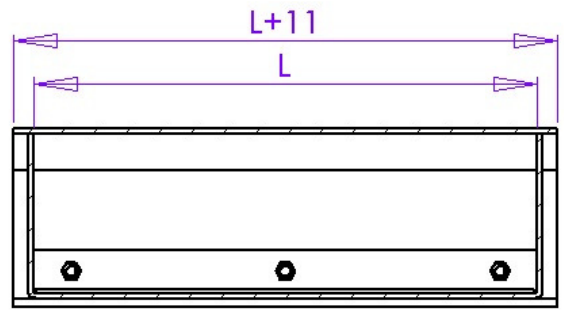
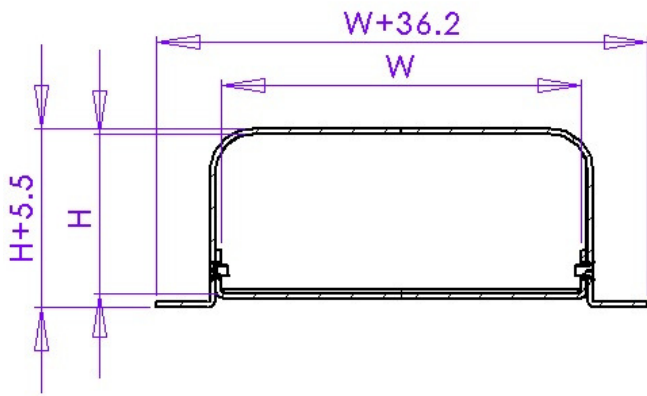
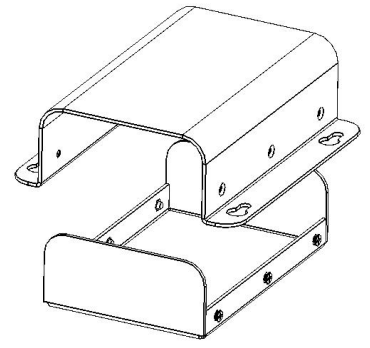



CSTM
R&D Solutions

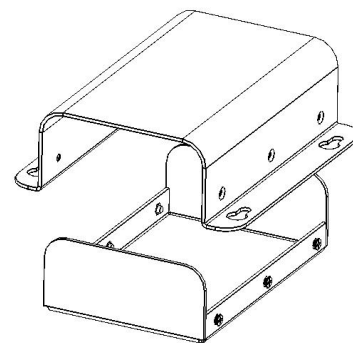

CSTM's Aluminum Project Boxes - FT2 Series - Selection Table

#	Mid P/N	Internal Dimensions			Useful Area [cm ²]	External Dimensions			Useful Int. Vol CC	Weight gr	Unit price break \$US/pc				
		W [mm]	L [mm]	H [mm]		W _E =W+36.2 [mm]	L _E =L+11 [mm]	H _E =H+5.5 [mm]			5 pc	25 pc	100 pc	300 pc	1000 pc
1	70x110x32	70	110	32	70	106.2	121	37.5	196	142					
2	75x115x34	75	115	34	79	111.2	126	39.5	236	157					
3	80x120x36	80	120	36	88	116.2	131	41.5	282	172					
4	85x125x38	85	125	38	98	121.2	136	43.5	333	189					
5	90x130x40	90	130	40	108	126.2	141	45.5	390	206					
6	95x135x42	95	135	42	119	131.2	146	47.5	453	223					
7	95x55x26	95	55	26	46	131.2	66	31.5	102	94					
8	100x140x44	100	140	44	131	136.2	151	49.5	522	242					
9	100x60x28	100	60	28	54	136.2	71	33.5	129	107					
10	105x145x46	105	145	46	142	141.2	156	51.5	598	261					
11	105x65x30	105	65	30	62	141.2	76	35.5	160	120					
12	110x70x32	110	70	32	70	146.2	81	37.5	196	134					
13	115x75x34	115	75	34	79	151.2	86	39.5	236	150					
14	120x80x36	120	80	36	88	156.2	91	41.5	282	165					
15	125x85x38	125	85	38	98	161.2	96	43.5	333	181					
16	130x90x40	130	90	40	108	166.2	101	45.5	390	198					
17	135x95x42	135	95	42	119	171.2	106	47.5	453	216					
18	140x100x44	140	100	44	131	176.2	111	49.5	522	234					
19	145x105x46	145	105	46	142	181.2	116	51.5	598	254					